

ZenBox Lockers

Aluminium and SGL lockers for wet area environments



Probe

ZenBox lockers

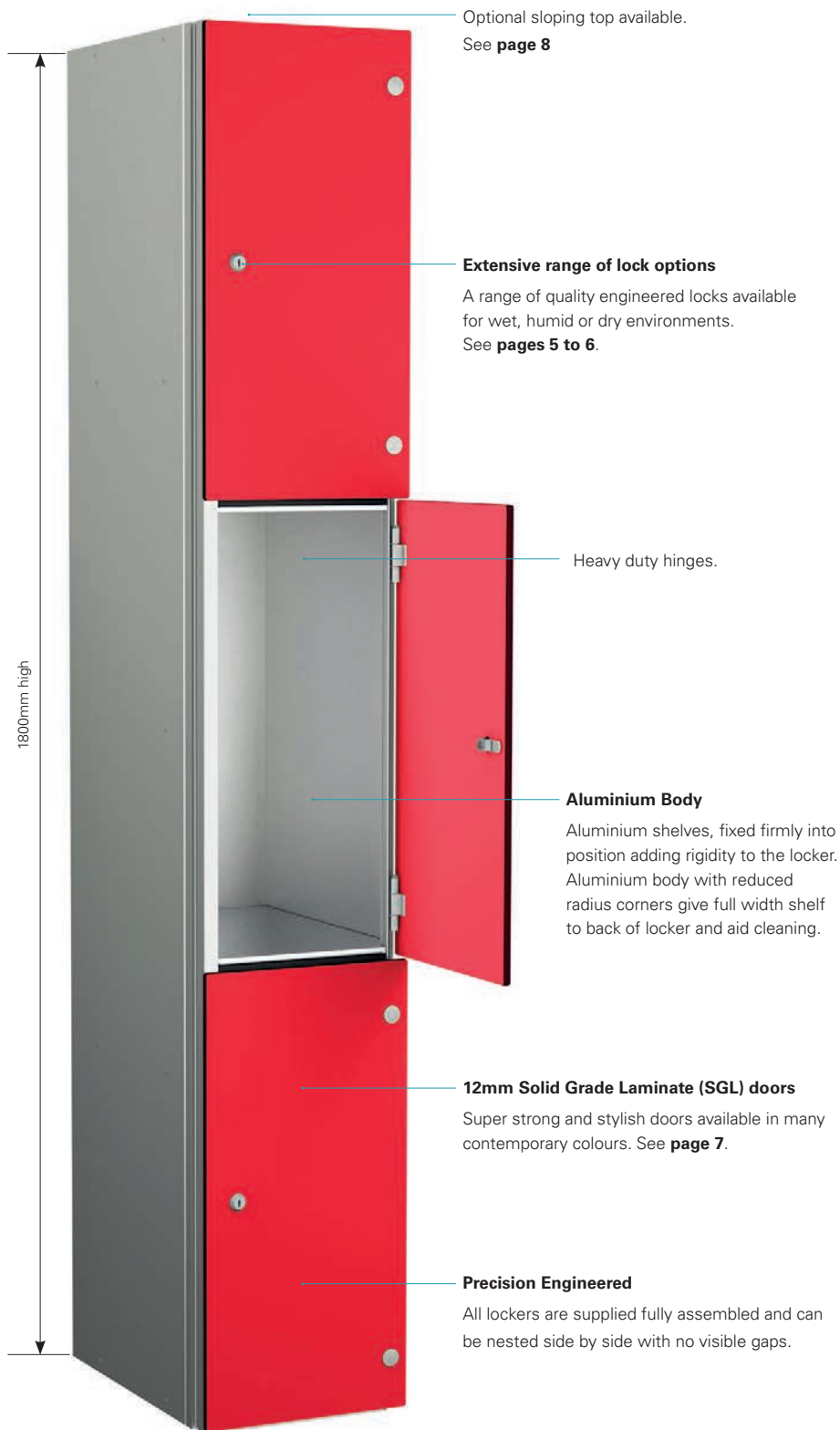

Optional sloping top available.
See **page 8**

Extensive range of lock options

A range of quality engineered locks available for wet, humid or dry environments.
See **pages 5 to 6**.

Heavy duty hinges.

Aluminium Body

Aluminium shelves, fixed firmly into position adding rigidity to the locker. Aluminium body with reduced radius corners give full width shelf to back of locker and aid cleaning.

12mm Solid Grade Laminate (SGL) doors

Super strong and stylish doors available in many contemporary colours. See **page 7**.

Precision Engineered

All lockers are supplied fully assembled and can be nested side by side with no visible gaps.

Designed and engineered ZENBOX lockers are the perfect choice for demanding environments.

ZENBOX lockers are designed and engineered to withstand the rigours of high use wet area environments where the requirements of design with durability and image are paramount.

- Leisure Centres
- Swimming Pools
- Schools
- Gyms
- Spas



Important note regarding locker installations

Wherever possible lockers should be secured to ensure stability. Single lockers should ideally be fixed back to a wall. Runs of lockers should be fixed together side-to-side and either fixed back to a wall or fixed back-to-back to another run of lockers.

ZenBox locker range

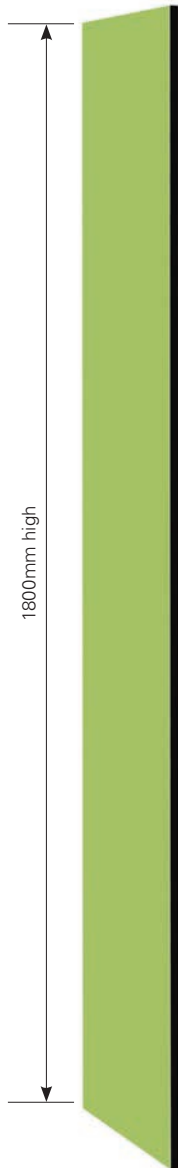

End panels to match doors

End panels can be manufactured to add on to the end of locker runs or to the side of each individual locker if required.



Single compartment

Fixed top shelf with double coat hook.

Two compartment

Double coat hook per compartment.

Three compartment

Four compartment

Six compartment

Height - 1800mm*	
Width mm	Depth mm
300	450
300	500
400	450

* Height rises by 150mm with sloping top

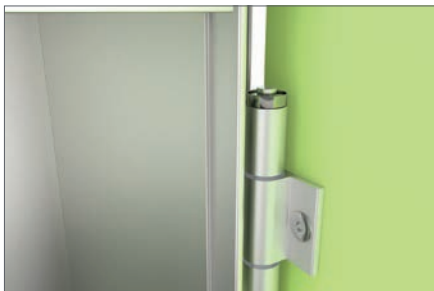

Heavy duty self-closing hinges engineered to prevent the doors opening across adjacent compartment.

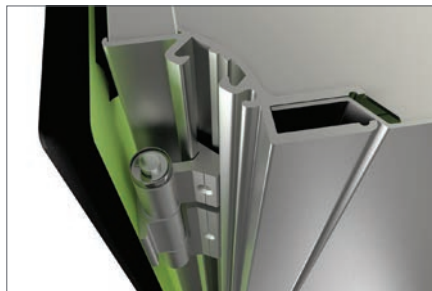

Concealed hinge within extruded aluminium frames engineered for added strength and stability.

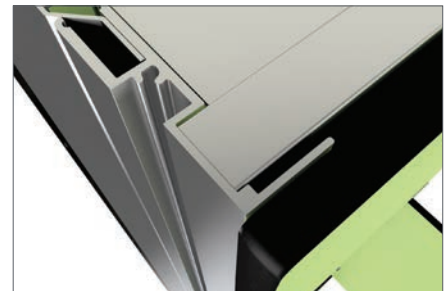

Flush frame for zero gap when lockers are nested.

ZenBox Ultra outdoor lockers



Sloping top

ZenBox Ultra lockers feature sloping tops to aid water dispersion.

Height - 1800mm*	
Width mm	Depth mm
300	450
300	500
400	450

Available in 1, 2, 3, 4 and 6 compartments



Integral door seal

This seal ensures there is no water ingress into the locker compartment.



Important note regarding locker installations

Wherever possible lockers should be secured to ensure stability. Single lockers should ideally be fixed back to a wall. Runs of lockers should be fixed together side-to-side and either fixed back to a wall or fixed back-to-back to another run of lockers.

Wet area lock options



Type 3 Probe cam lock*

Even the standard lock has a micro sprung 10 disc lock featuring a massive 3000 serial combinations- all exclusive to Probe. Two keys are included with each standard lock.



Type 2 Hasp and staple*

Attractive design allowing easy use of padlock fitting. Shank diameter maximum 7mm and minimum 5mm
Padlock sold separately.

Replacement hasp & staple

This Hasp & Staple is available to purchase separately if you need to change your existing lock.



Type 11 Re-programmable combination lock

User re-programmable.
An effective 4 digit code combination lock with 10,000 possible combinations, making losing keys a thing of the past.
NOT Suitable for multi user applications. Master override key sold separately.

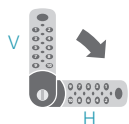

Type 6 Digital combination lock 40,000 combinations

Simple to program battery operated lock which can last up to 50,000 operations before needing changing. Emergency access using service key. Single user supplied as standard but multi-user option is available (specify when ordering)**Can be used vertically**

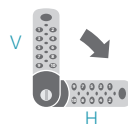

Type 10 The RFID keyless digital combination lock

This lock provides contact less RFID locking and can be used independently or paired with existing wireless systems. Simple to upgrade existing installations and compatible with most wireless standards including RFID and NFC, the lock comes with a wide range of accessories and options.



Type 8 Waterproof coin/token Return/Retain

These Waterproof and Chlorine resistant locks are available with coin denominations £/€ or tokens, for either return or retain..



Laminate door colour options

Create a storage solution that closely matches your branding or blends subtly into the background with a range of coloured door options to choose from.

Choose from our Standard range or specify a  laminate to match your architectural design.

Solid grade laminate with fire classification available at additional cost.

Please ask us for further information on fire classifications and applications.



ZENBOX and ZENBOXULTRA stock 12mm SGL SOLID COLOUR finishes - aluminium body

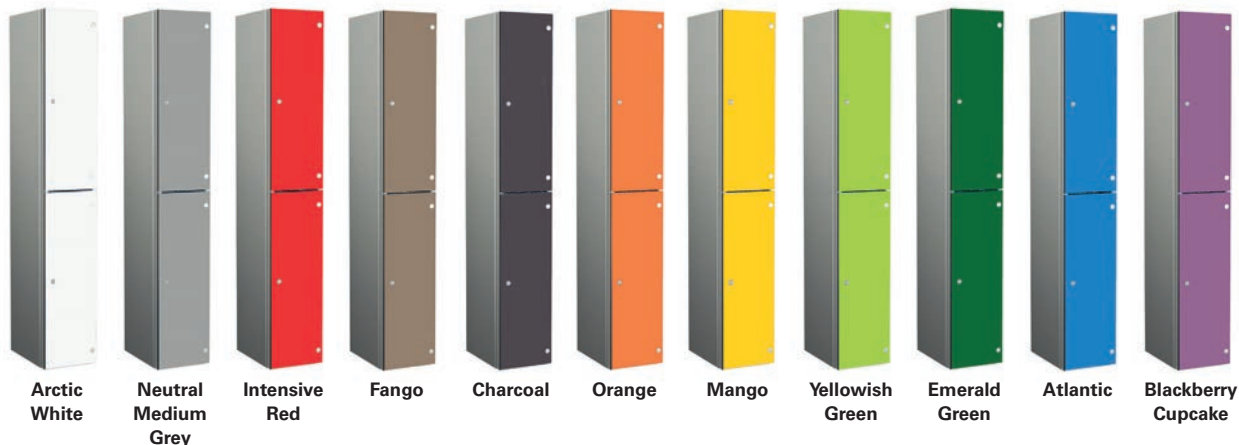

ZENBOX and ZENBOXULTRA additional 12mm SGL SOLID COLOUR finishes, available on an extended lead time.

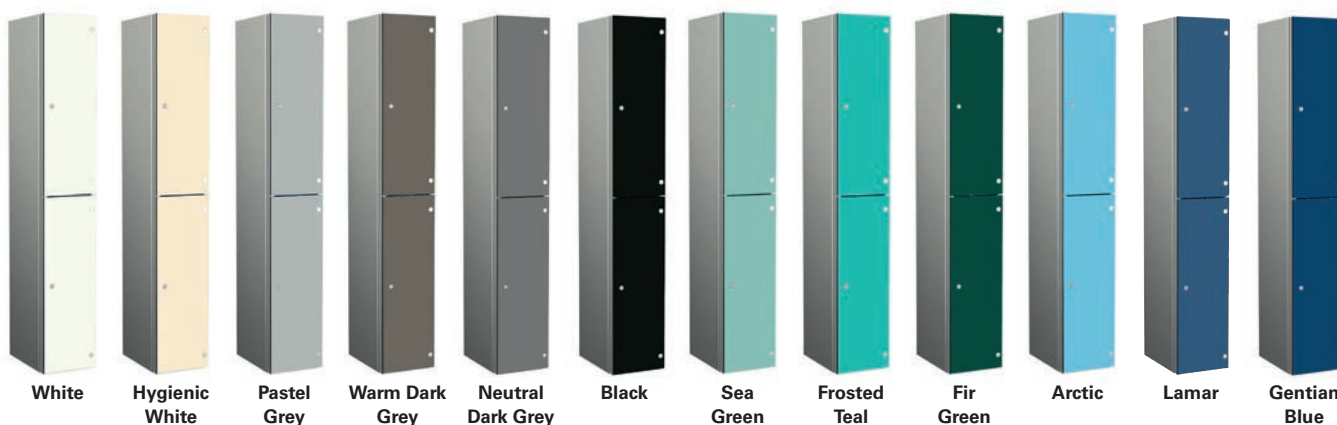

ZENBOX and ZENBOXULTRA stock 12mm SGL TEXTURED finishes



ZENBOX and ZENBOXULTRA additional 12mm SGL TEXTURED finishes, available on an extended lead time.



Please note that due to printing restrictions colours represented may differ from original product. We recommend you request a colour swatch before ordering.

Accessories

Aluminium Locker Support Stands

Locker support stands raise lockers off the floor, reducing impact damage and making cleaning easier. Manufactured from 25mm square aluminium section they are ideal for wet environments.

All units come complete with adjustable feet to aid levelling on uneven floors.

Optional 10mm solid grade laminate (SGL) plinth available to match or contrast with the locker doors.

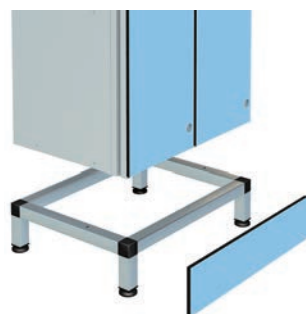
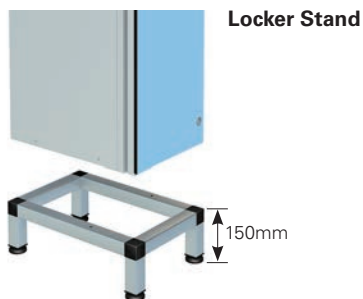

Locker stand with plinth

Locker stand plinths are manufactured using 10mm Solid grade laminate (SGL) to match or contrast with the locker doors.

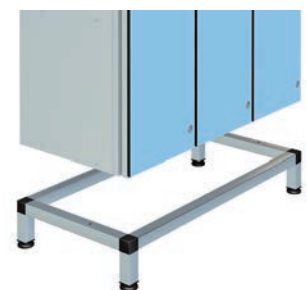

Aluminium Seats and Stands

10mm solid grade laminate seat (SGL) and 45mm aluminium framework form a bench seat in front of the locker, allowing full access to the locker.

Seat can match or contrast with the locker door or with an optional SGL plinth.

All units come complete with adjustable feet to aid levelling on uneven floors.

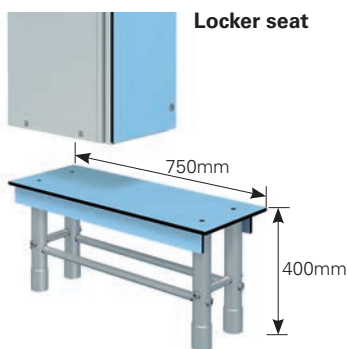

Locker seat plinths

Locker seat plinths are manufactured using 10mm solid grade laminate (SGL) to match or contrast with the locker doors.



Sloping Top

Sloping tops are a good way of preventing litter, bags and other items being left on top of the lockers. The sloping top also makes cleaning easier. Sloping tops are essential in hygiene – sensitive applications such as the NHS or food preparation. Sloping tops add 150mm height to the locker.



Numbering System

Optional inset number plates are available. Discs are recessed into the door. Request when placing order.



Probe

01244 940792

| info@probe-lockers.ltd.uk

| www.probe-lockers.ltd.uk